

RGB/CCT/Dimming 3 Channel LED RF Controller

- Match with RF 2.4G single zone or multiple zone single color, dual color and RGB/RGBWW remote control.
- One RF controller accept up to 10 remote control.
- 4096 levels 0-100% dimming smoothly without any flash.
- When using with RGB light, built in 10 dynamic mode, include jump or gradual change style.
- Auto-transmitting function: Controller automatically transmit signal to another controller with 30m control distance.
- Synchronize on multiple number of controllers.
- Light on/off fade time 3s selectable.
- Connect with external push key to achieve on/off and 0-100% dimming function.
- Over-heat / Over-load / Short circuit protection, recover automatically.

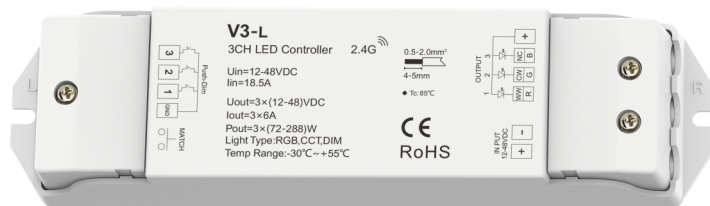

CE RoHS  LVD RED

Technical Parameters

Input and Output		Dimming data		Safety and EMC	
Input voltage	12-48VDC	Input signal	RF 2.4GHz + Push Dim	EMC standard (EMC)	ETSI EN 301 489-1 V2.2.3 ETSI EN 301 489-17 V3.2.4
Input current	18.5A	Control distance	30m(Barrier-free space)	Safety standard(LVD)	EN 62368-1:2020+A11:2020
Output voltage	3x(12-48)VDC	Dimming gray scale	4096 (2 ¹²) levels	Radio Equipment(RED)	ETSI EN 300 328 V2.2.2
Output current	3CH,6A/CH	Dimming range	0 -100%	Certification	CE,EMC,LVD,RED
Output power	3x(72-288)W	Dimming curve	Logarithmic	Environment	
Output type	Constant voltage	PWM frequency	1000Hz (default)	Operation temperature	Ta: -30°C ~ +55°C
Warranty		Package		Case temperature (Max.)	Tc: +85°C
Warranty	5 years	Size	L178x W50 x H38mm	IP rating	IP20
Protection	Reverse polarity,Over-heat Over-load,Short circuit	Gross weight	0.130kg		

Mechanical Structures and Installations

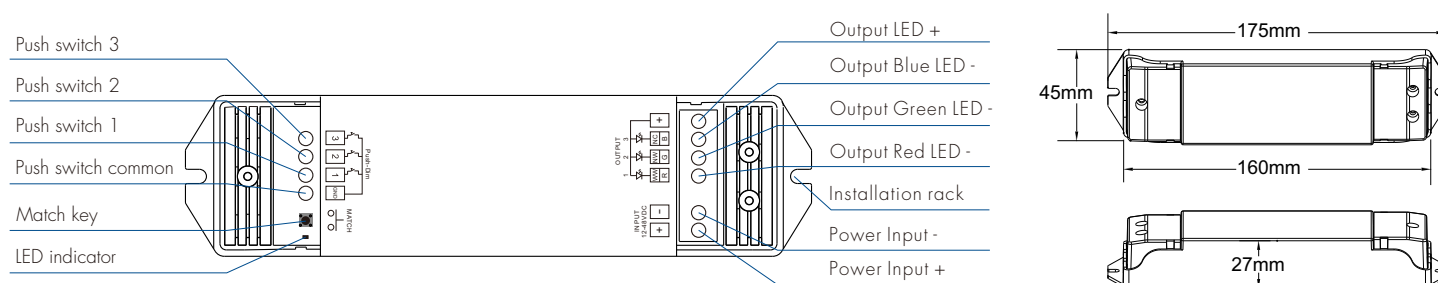

Match Remote Control (two match ways)

End user can choose the suitable match/delete ways. Two options are offered for selection:

Use the controller's Match key

Match:
Short press match key, immediately press on/off key (single zone remote) or zone key (multiple zone remote) of the remote.
The LED indicator fast flash a few times means match is successful.

Delete:
Press and hold match key for 5s to delete all match,
The LED indicator fast flash a few times means all matched remotes were deleted.

Use Power Restart

Match:
Switch off the power of the receiver, then switch on power, repeat again.
Immediately short press on/off key (single zone remote) or zone key (multiple zone remote) 3 times on the remote.
The light blinks 3 times means match is successful.

Delete:
Switch off the power of the receiver, then switch on power, repeat again.
Immediately short press on/off key (single zone remote) or zone key (multiple zone remote) 5 times on the remote.
The light blinks 5 times means all matched remotes were deleted.

Wiring Diagram

• V3-L for RGB

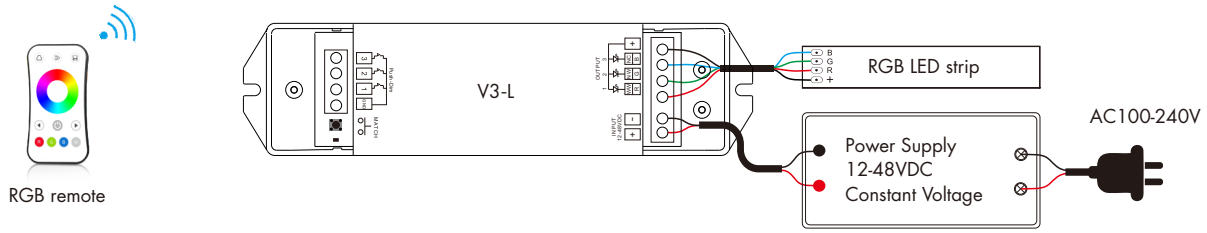

• V3-L for dual color

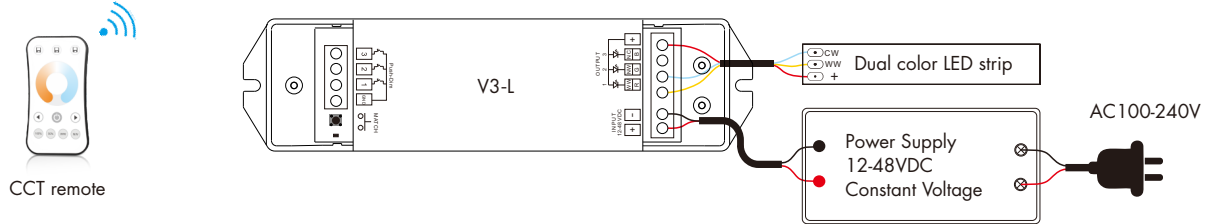

• V3-L for single color

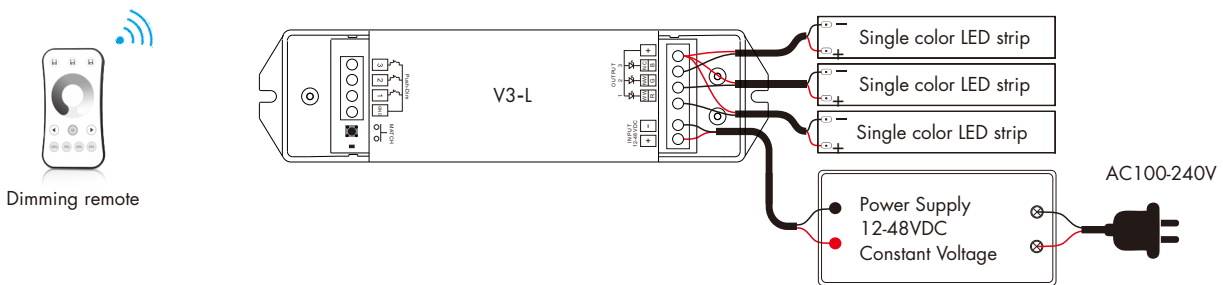

• V3-L with three push key for 3 channel single color

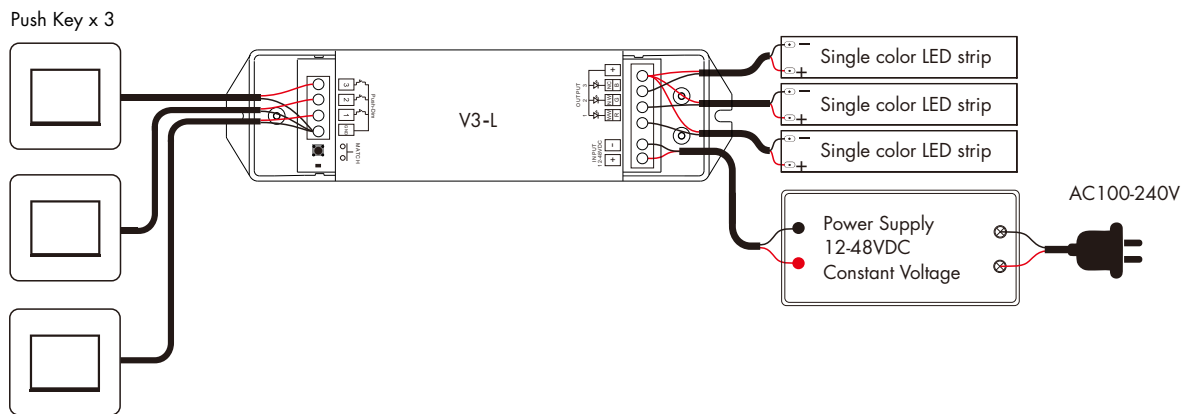

Wire Preparation:

1. The wiring can be solid or stranded with a cross-sectional area of 0.5 to 2 mm².
Conventional 1mm² can withstand 10A output current.
2. When wiring is installed, the terminals must be tightened.
If they are not tightened, the contact point resistance will be too high and the terminals will easily burn due to heat when used at full load for a long time.

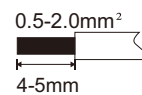

Note: The output power of a constant voltage power supply should be at least 1.2 times that of the output load (light strip), otherwise the full power output of the load can easily cause automatic flickering or shaking of the light.

Light on/off fade time

Long press match key 5s, then short press match key 3 times, the light on/off time will be set to 3s, the indicator light blink 3 times.
Long press match key 10s, restore factory default parameter, the light on/off time also restore to 0.5s.

Push-Dim control

The 3 push key have 3 channel dimming function defaultly.

- **Short press:** Turn on or off each channel.
- **Long press (1-6s):** Press and hold to step-less dimming of each channel,
With every other long press, the light level goes to the opposite direction.
- **Dimming memory:** Light returns to the previous dimming level when switched off and on again.

You also can long press push key and Match key at the same time to select 3 kinds light type, and each light type will have different push key function.

Long press 1 key and Match key 2 seconds, set as 3 channel single color type (default).

Long press 2 key and Match key 2 seconds, set as dual color type.

Long press 3 key and Match key 2 seconds, set as RGB type.

at this time, if the light type has set as dual color or RGB, match remote will not change light type.

If you want to cancel light type set, please long press Match key 10 seconds to restore factory setting.

Single color (3 CH)	1 key	Short press turn on/off 1 channel, long press 1-6s dim up/down
	2 key	Short press turn on/off 2 channel, long press 1-6s dim up/down
	3 key	Short press turn on/off 3 channel, long press 1-6s dim up/down
Dual color	1 key	Short press turn on/off light, long press 1-6s dim up/down
	2 key	Short press 3 levels color temperature (WW, NW, CW), long press 1-6s color temperature up/down
	3 key	Invalid
RGB	1 key	Short press turn on/off light, long press 1-6s dim up/down
	2 key	Short press change dynamic mode, long press 2s to set speed (1-10 levels)
	3 key	Short press change static RGB color (24 levels), long press 1-6s adjust saturation

RGB dynamic mode list

No.	Name	No.	Name
1	RGB jump	6	RGB fade in and out
2	RGB smooth	7	Red fade in and out
3	6 color jump	8	Green fade in and out
4	6 color smooth	9	Blue fade in and out
5	Yellow cyan purple smooth	10	White fade in and out

Malfunctions analysis & troubleshooting

Malfunctions	Causes	Troubleshooting
No light	1. No power. 2. Wrong connection or insecure.	1. Check the power. 2. Check the connection.
Wrong color	1. Wrong connection of R/G/B wires.	1. Reconnect R/G/B wires.
Uneven intensity between front and rear, with voltage drop	1. Output cable is too long. 2. Wire diameter is too small. 3. Overload beyond power supply capability. 4. Overload beyond controller capability.	1. Reduce cable or loop supply. 2. Change wider wire. 3. Replace higher power supply. 4. Add power repeater.
No response from the remote	1. The battery has no power. 2. Beyond controllable distance. 3. The controller did not match the remote.	1. Replace battery. 2. Reduce remote distance. 3. Re-match the remote.

Installation Precautions

1. The products shall not be stacked, the distance should be $\geq 20\text{cm}$, so as not to affect lifespan of the products due to poor heat dissipation.
2. The product shall not be installed close to the switching power supply with an interval of $\geq 20\text{cm}$ to avoid radiation interference of the switching power supply.
3. The installation height shall be $\geq 1\text{m}$ from the floor to avoid shortening the remote control distance due to too weak reception signal.
4. The products are not allowed to be close to or covered by metal objects, with an interval of $\geq 20\text{cm}$ to avoid signal attenuation and shorten the remote distance.
5. Avoid installation at the corner of the wall or the corner of the beam, with an interval of $\geq 20\text{cm}$ to avoid signal interference.